

MOTORIZED CELLULAR SHADE WITH DUAL MOTOR MANUAL

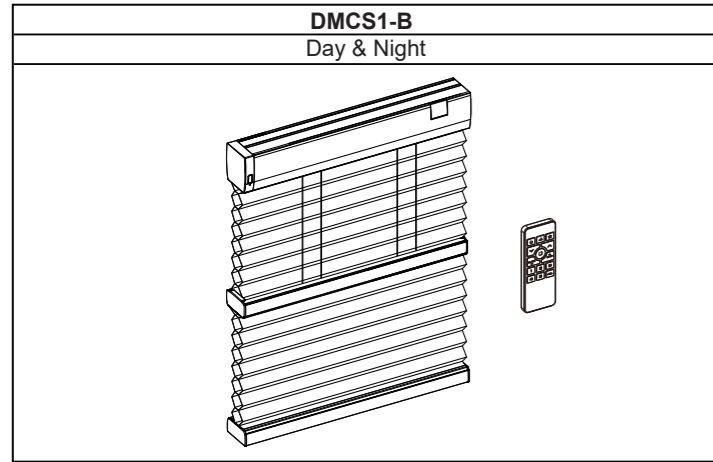

NO.	Item	Specification
1	Power Source	DMCS1-B: Li-ion Battery
2	Input	DMCS1-B: 24V, 1.5A Max
3	Output	DMCS1-B: 10.89V, 1.3A Max.
4	Radio type	2.4G RF
5	Motor type	Brush DC motor
6	Charging type	Power Charger PB-01S Power Charger PB-02
7	Charging Time	< 2 hours
8	Charging Temperature	5°C ~ 35°C / 41°F ~ 95°F
9	Operating Temperature	0°C ~ 40°C / 32°F ~ 104°F
10	Relative Humidity	0% ~ 90% (Non-condensing)

FCC ID: Q3V-DMCS1
IC ID: 28542-DMCS1
CAN ICES-003 (B) / NMB-003(B)

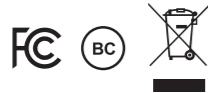

READ BEFORE INSTALLATION

▲WARNING! Important safety instructions. Follow all instructions since incorrect installation can lead to severe injury.

Before installing the device, remove any unnecessary cords or components and disable any equipment not needed for powered operation.

▲WARNING! The installation height will vary according to product type or installation situation and may exceed 98.43" (2.5m).

▲WARNING! For shades powered by battery (DMCS1-B), please turn on the shade **AFTER** installation. Press and hold the shade button for 3 seconds, and the green light will flash, which means the shade is powered on.

Reserve space before installation :

For Model# DMCS1-B : with built-in Li-ion battery pack and charging accessories.

▲IMPORTANT! For Model #DMCS1-B with built in Li-ion battery pack, please mount the headrail correctly. Make sure the headrail is level and that it doesn't tilt forward. Improper installation may cause the charging wand to not make full contact with the charging port. The shade installation only allows up to 3° of deflection tolerance.

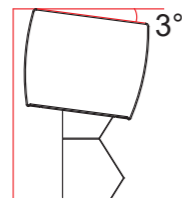

TOOLS YOU WILL NEED

- Level
- Measuring Tape
- Pencil
- Power Drill (6mm hex driver and drill bit)
- Screwdriver



You will need to use the following fasteners for your particular mounting surface.

Surface	Fastener
Wood	Screws (Provided)
Drywall/Plaster	Wall Anchors, Expansion Bolts (Not Provided)
Metal	Sheet Metal Screws (Not Provided)

GETTING STARTED

Check Standard Components/Hardware:

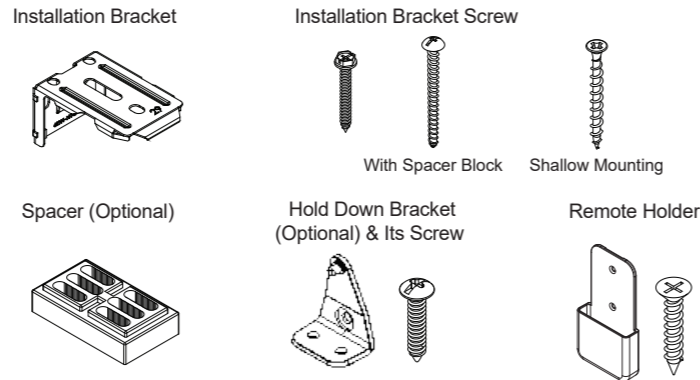

Hardware Standard Quantity:

Order Width (X)	Less or Equal to 64"	Between 64-1/8" and 112"	Over 112"
Installation Bracket	2	3	4
Installation Bracket Screw	4	6	8
Spacer Block (Optional)	Varies per order request: 1pc / bracket or 2pcs/bracket		
Hold Down Bracket (Optional)	2	2	2
Hold Down Bracket Screw (Optional)	4	4	4

Check Components for DMCS1-B for Battery:

Charging Wand (Optional)

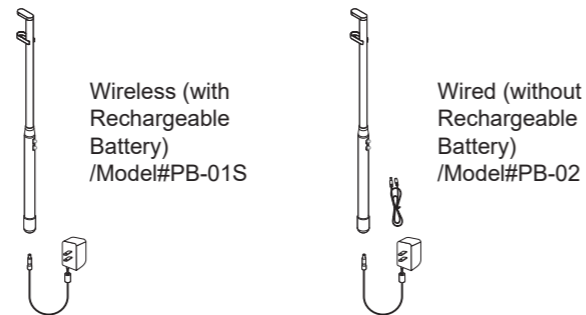

MOUNTING INSTALLATION BRACKETS

The installation bracket may be used for **INSIDE** or **OUTSIDE** mounts.

Please always avoid the charging port when placing the brackets. Mounting the brackets level is essential for proper operation of the shade.

Shim the brackets if necessary to achieve a level alignment. The bracket requirements and placement are the same for inside and outside mount.

Measure 8" from both ends of the headrail. Mark the bracket location on the mounting surface. Proper alignment of brackets will make installation easier.

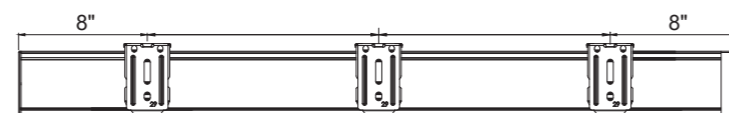

Inside Mount:

Allow a minimum of 1/16" distance from the front of brackets to the edge of window opening as shown in the drawing on the right. Use two installation screws to secure brackets. Use wall anchors for drywall or plaster wall.

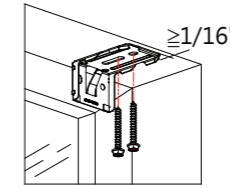

* For shallow mounting, use 2 flat head screws to secure the bracket as shown in the drawing on the right.

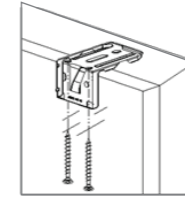

Outside Mount:

Use 2 flat head screws to secure each bracket. Use wall anchors for drywall or plaster wall.

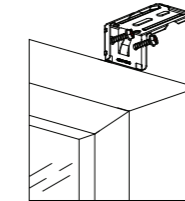

Note: If spacer block is provided, please follow this guide: Please always make sure the raised side of the spacer block is against the bracket.

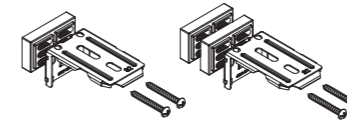

Install the Shade:

Position the head rail at an angle so that it is hooked to the front of the bracket. Then push it upward at the back to snap into the bracket.

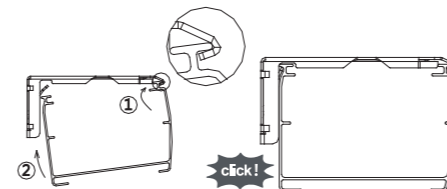

Note: You will hear a click sound once the head rail is properly secured.

Install Hold Down Bracket (Optional):

A. For Hold Down Brackets.
Use screw to secure each bracket.



Inside Mount Outside Mount

B. For Magnetic Hold Down

Use M3x15mm screw to secure the magnet catch at the below location. Make sure the magnet catch align with the pre-installed magnet on shade bottom rail.

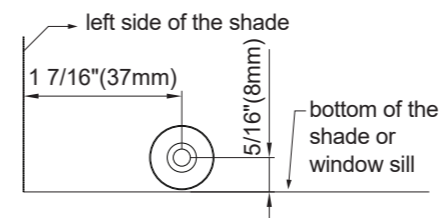

Remote Holder Installation

A. Plaster Wall (Use Installation Screws)

1. Place the remote holder at desired location, and use the pencil to mark the locations of the screws.

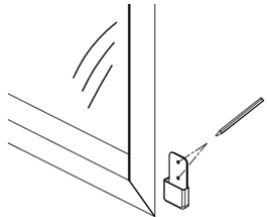

2. Place the remote holder against the wall and use two installation screws to secure the remote holder.

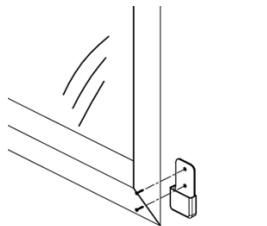

B. Smooth Wall (Marble Wall, Quartz Wall, Glass - Use Adhesive Sticker)

For hard surfaces, such as marble, quartz, etc. it is recommended to use the double-sided foam tape provided.

REMOVING THE SHADE

Fully raise the shade, and then gently remove the bracket off the headrail with a flat screwdriver.

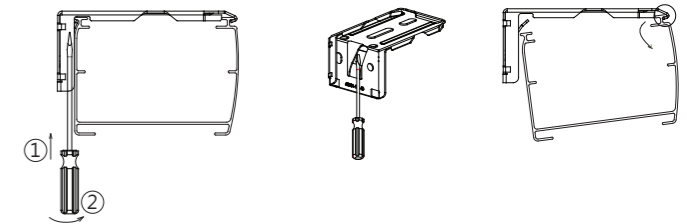

Congratulations! You have finished installing the product.

Please also note that for shades with rechargeable batteries, the batteries will come with enough power to test your shade immediately after installation. Rechargeable batteries will be shipped out with approximately 50% battery to allow for testing. However, it is recommended to charge your battery to full before using your shade for other purposes. To check the battery level, please refer to the power charger manual.

Scan to learn more

