

Installation Instructions

Honeycomb Shades

Patio Door Vertical & Vertical Day&Night

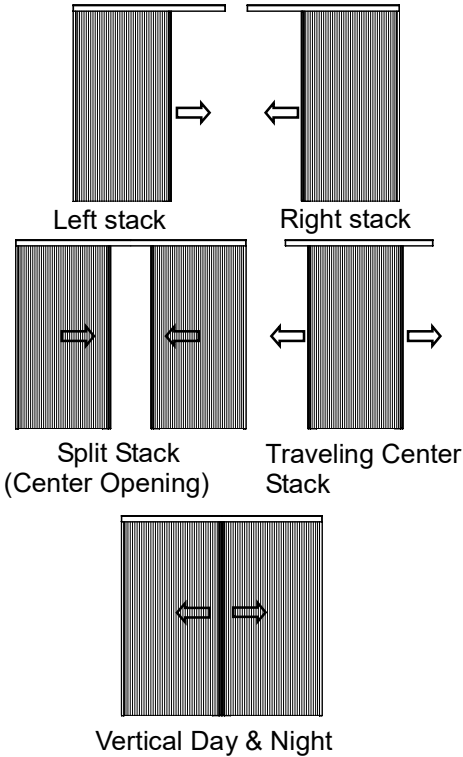

Getting Started



Remove the shade from the package. Save the packaging until the shade is installed and working to your satisfaction.

Tools Needed :

- Power drill and drill bit
- Measuring tape
- Screwdriver
- Level
- Pencil
- Pliers

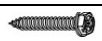

You will need to use the following fasteners for your particular mounting surface.

Surface	Fastener
Wood	1 1/4" Hexagonal Head Screws (Provide) 
Drywall/Plaster	Wall Anchors, Expansion Bolts (Not Provide) 
Metal	Sheet Metal Screws (Not Provide) 

Check Component/Hardware:



Installation Bracket

For non-split rail:
 $X \leq 39" \times 2$
 $39" < X \leq 66" \times 3$
 $66" < X \leq 93" \times 4$
 $93" < X \leq 120" \times 5$
 For split rail:
 $84" < X \leq 93" \times 4$
 $93" < X \leq 146" \times 6$

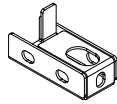

Floor Bracket

Right stack x1
 Left stack x1
 Split Stack (Center Opening) x2
 Vertical Day & Night x2



Bolt

Right stack x1
 Left stack x1
 Traveling Center Stack x2
 Split Stack (Center Opening) x2
 Vertical Day & Night x2



Hanger
Same as clip qty



Adjustment Sheet (IM)
(Optional)

For non-split rail:
 $X \leq 39" \times 2$
 $39" < X \leq 66" \times 3$
 $66" < X \leq 93" \times 4$
 $93" < X \leq 120" \times 5$
 For split rail:
 $84" < X \leq 93" \times 4$
 $93" < X \leq 146" \times 6$



1 1/4" Screw for Bracket

Installation bracket qty x2
 (Hexagonal Head)
 +
 Floor bracket qty (round head screw)



M3.8 Screw & adjustment sheet(IM)

$X \leq 39" \times 2$
 $39" < X \leq 66" \times 3$
 $66" < X \leq 93" \times 4$
 $93" < X \leq 97 \ 5/8" \times 5$
 $97 \ 5/8" < X \leq 146" \times 6$

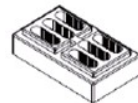

Spacer Block (Optional)

1pc to extend distance 3/8"
 2pcs to extend distance 11/16"

Step 1: Bracket Installation

Measure 3"-4" from both ends of the head rail. Evenly space the brackets and mark the locations on the mounting surface. Proper alignment of brackets will make installation easier.

a. Headrail - no split

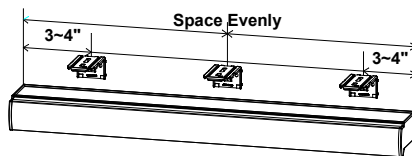

b. Headrail - split evenly (Included Connector*1pc & Keystone*1pc)

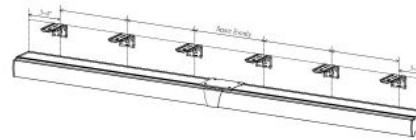

Inside Mount:

Option 1: Without installation brackets

Put the provided adjustment sheet next to screw hold on head rail. Secure the head rail with M3.8 screws to the top of window frame. Use wall anchors for drywall or plaster wall.

a. Headrail - no split

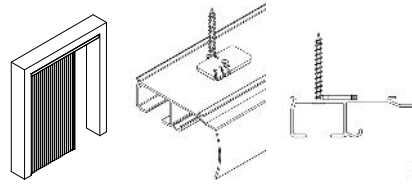

b. Headrail - split evenly

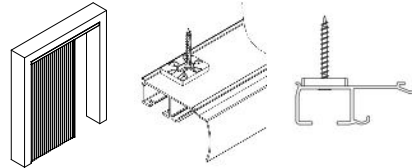

Option 2: With installation brackets

Align the front of bracket flush against the wall. Secure each bracket with two 1 1/4" mounting screws. Use wall anchors for drywall or plaster wall.

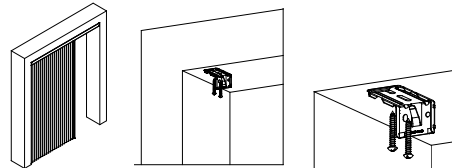

One finished, go to Step 2: Shade Installation.

Outside Mount:

Position the top of bracket at order height +1/8". Use two 1 1/4" mounting screws (Hexagonal Head) to secure brackets. Use wall anchors for drywall or plaster wall.

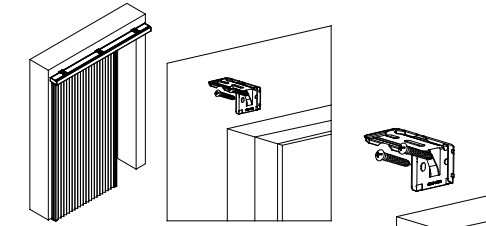

Step 2: Shade Installation

a. Position head rail at an angle so that it hooks into the front of the brackets. Then push upward to snap the head rail into the brackets.

 For proper installation, start by attaching the front rail to the bracket and ensure to stick right in place.

Note: You will hear a click sound once the head rail is properly secured.

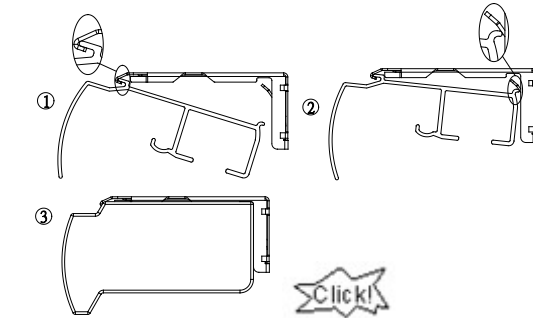

b. Attach the hangers (found in the hardware box) to the clips (pre-attached on the blanket) at the top of the shade.

For convenient operation, reverse the shade when opening the package and face to the back of blanket.

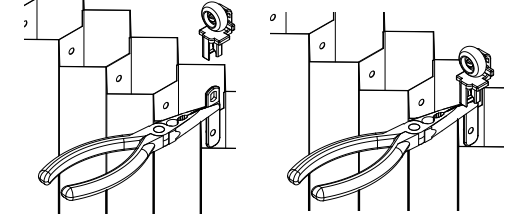

c. Install fixed vertical rail

Push the fixed vertical rail from down to up as below drawing shows. Attach fixed vertical rail by pushing the fixing hanger into the gap of head rail as the drawing shows.

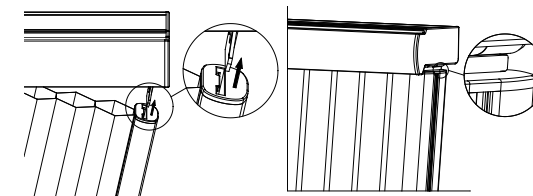

d. Install movable vertical rail

Align the hanger shaft hole with the sliding supporting shaft hole, and insert the bolt into the shaft hole completely (1). Tighten the bolt completely (2).

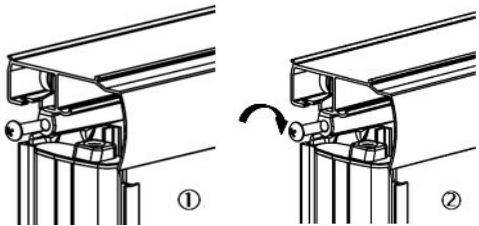

e. Untie the cords. Put the buckle bead into groove of headrail end cap on the movable rail side (make sure the buckle bead goes into the groove top down) as drawing shows.

Notes: 1. For Left Stack, Split Stack (Center Opening) left shade and Day & Night left shade, put the buckle bead into groove of right headrail end cap.

2. For Right Stack, Split Stack (Center Opening) right shade and Day & Night right shade, put the buckle bead into groove of left headrail end cap.

3. For Traveling Center Stack, put the buckle bead from right movable rail into groove of right head rail end cap; put the buckle bead from left movable rail into groove of left head rail end cap.

⚠ Please make sure the cord end and the buckle bead are on the upward side of the groove.

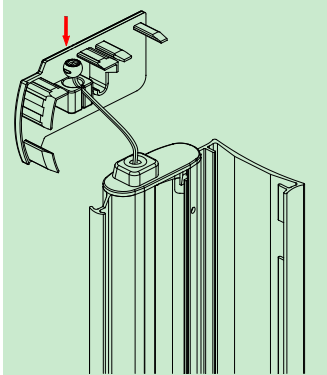

f. Press hangers onto the head rail from the front of the shade. Make sure the hangers are in the front of the middle groove in head rail.

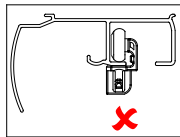
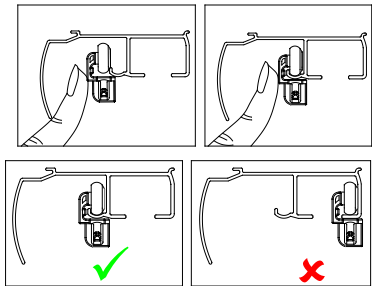

g. Attach the floor bracket to the end cap of fixed vertical rail, shown in left drawing shows.

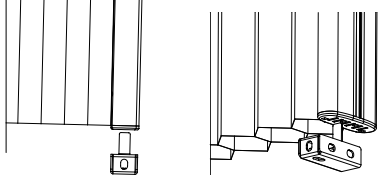

Make sure the rail is aligned straight with the floor and wall. With the provided screw, secure the floor bracket to the floor or to the wall shown below. Floor bracket has been pre-attached to the end cap of fixed vertical rail.

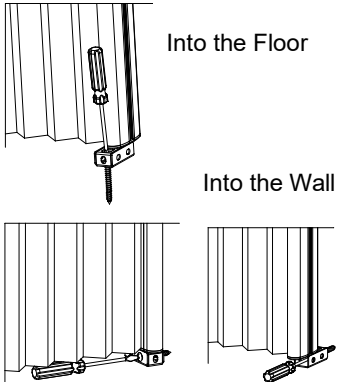

h. If the vertical rail is not aligned straight up and down, adjustment is necessary. Tighten or loosen the screw to adjust the movable rail so it is aligned straight.

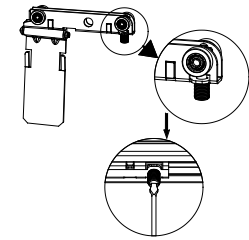
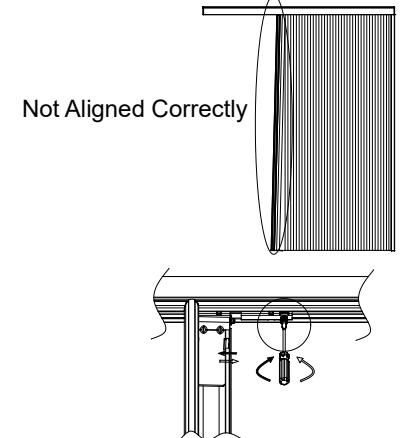

Shade Removal

a. Unloosen the bolt from the shaft hole.

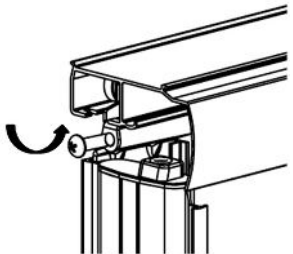

b. Loosen the screw at the back of the fixed vertical rail and push the bracket to uninstall.

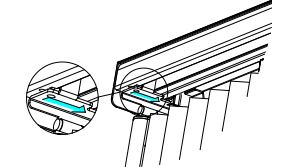
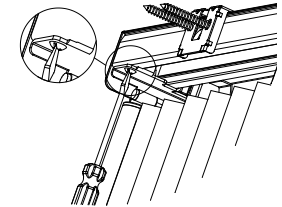

c. Use the reverse steps to uninstall the shade

Note: Separate clips from hangers as below drawing shows, and leave the hangers on head rail.

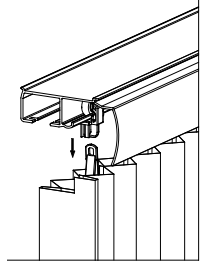

Gently pry the brackets off the head rail with a flat screwdriver as next diagram shows.

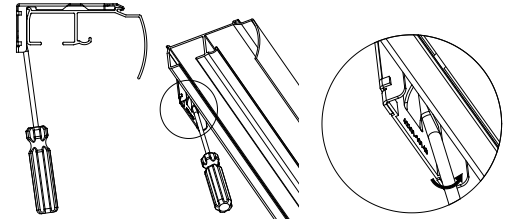

Installation of spacer block (for OB)

For installation bracket: Install the spacer block (1pc or 2pcs) in the back of the installation bracket as the next diagram shows.

Extend up to 3/8" for 1pc spacer block. Extend up to 11/16" for 2pcs spacer block.

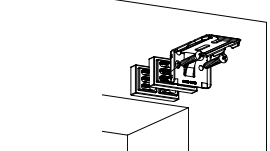

For floor bracket: Install the spacer block (1pc or 2pcs) at the backside of the Floor bracket as the next diagram shows.

Extend up to 3/8" for 1pc spacer block. Extend up to 11/16" for 2pcs spacer block.

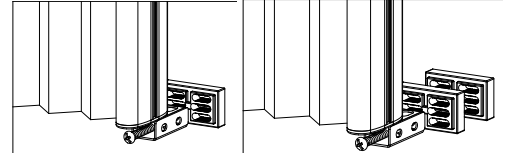

⚠ **Spacer block will be provided only when customer request.**