

Fauxwood & Normandy Blind Optional Hardware Installation Instructions

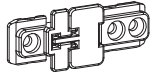

Valance Connector
(For FW Blind)

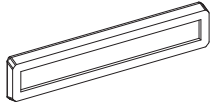

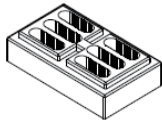

Valance Connector
(For Wood Blind)



Shim
(For OB only)



2" Screw
(For Shim)

Surface	Fastener
Wood	#8x2" Screws (Provide) 
Drywall/Plaster	Wall Anchors, Expansion Bolts (Not Provide) 
Metal	Sheet Metal Screws (Not Provide) 

Hardware Standard Quantity

Blind Width(X)	X ≤ 37"	37" < X ≤ 47"	47" < X ≤ 75"	75" < X ≤ 96"
Shim	1pcs for extend distance 3/8" 2pcs for extend distance 11/16"			
2" Screw (For Bracket with Shim)	4	6	8	10

Getting Started

NOTE: Prior to installation, please make sure your hands are clean and free from any dirt or oil that could cause damage to the blind.

Recommended Tools

- Measuring Tape
- Pencil
- Level
- Screwdriver
- Power drill
(1/4" hex driver and drill bit)



You will need to use the following fasteners for your particular mounting surface.

How to install Valance Connector

Valance Connector is only supplied for connecting spliced valances.

For Fauxwood Blind: Put the valance connector into the slot on the back of the valance as below drawing:

For 3.25" Designer Crown Valance:

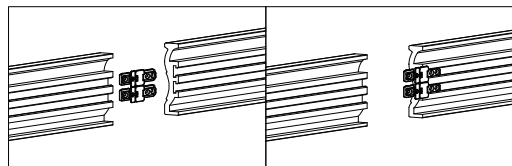

The valance is connected as below drawing:

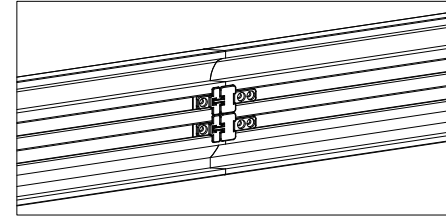

For 2.5" Modern Curved Valance:

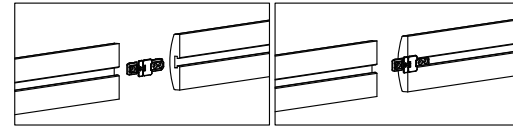

The valance is connected as below drawing:

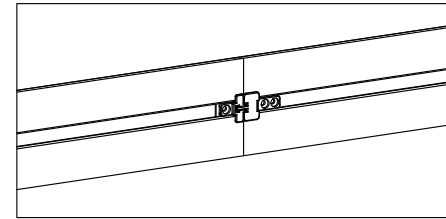

For Wood Blind: Insert the valance connector into the slot on the back of the valance as below drawing:

⚠ Make sure the wider side is facing downwards.

⚠ Do not remove the fiber tape and wood block

For 2.5" Contempo Valance:

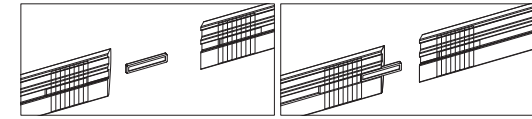
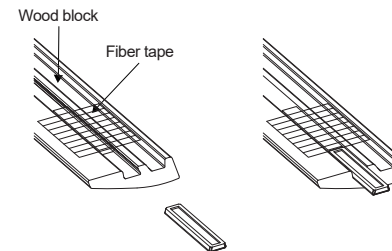

The valance is connected as below drawing:

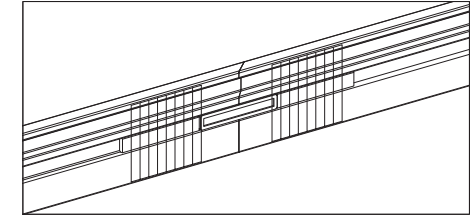

For 3.25" Designer Crown Valance:

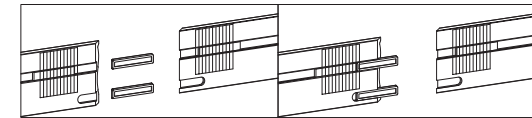
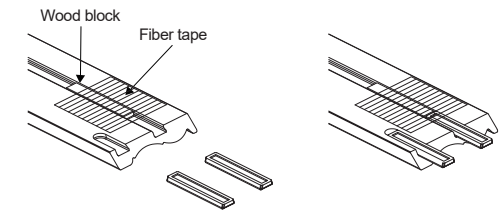

The valance is connected as below drawing:

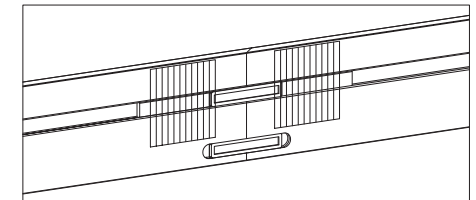

How to install Keystone

For Fauxwood blind: Put the split valance to the keystone as below drawing. Use screws to secure the back of the keystone.

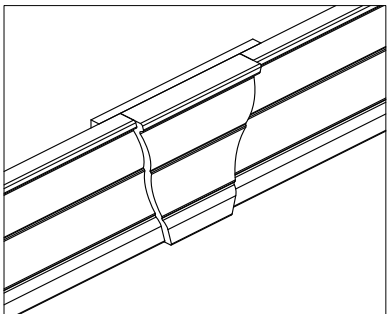
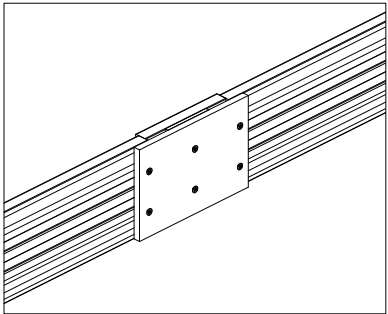
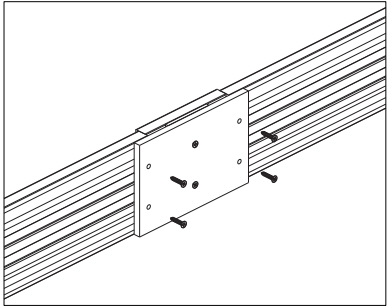
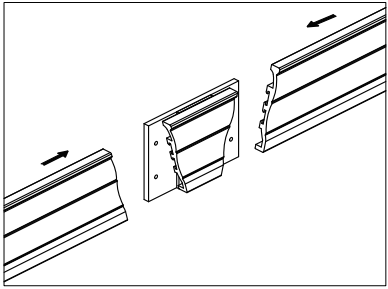

For Wood Blind: Put the split valance to the keystone as below drawing. Use valance connector & 2pcs of screws to secure the back of the keystone.

For 2.5" Contempo Valance (Wood):

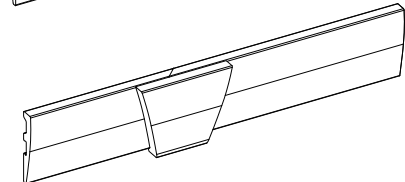
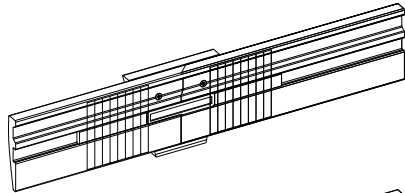
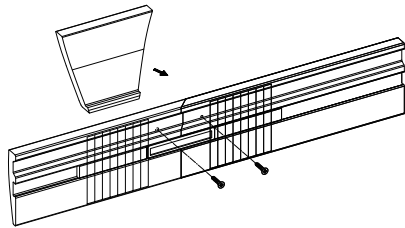
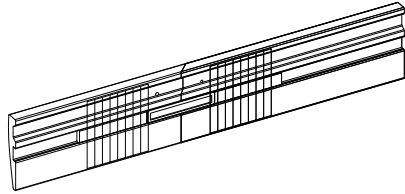
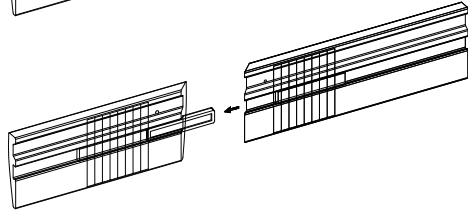
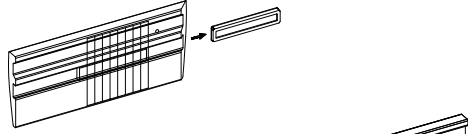

For 3.25" Designer Crown Valance (Wood)

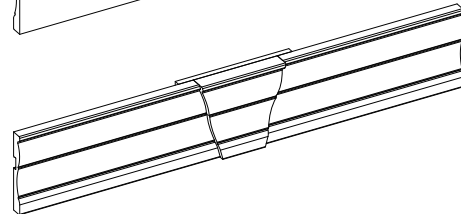
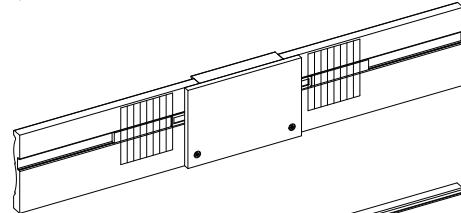
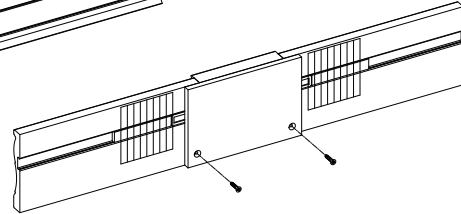
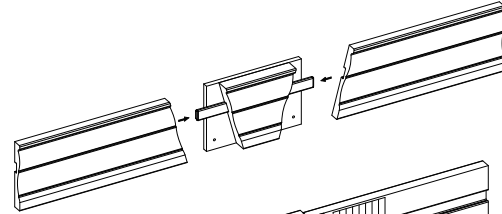
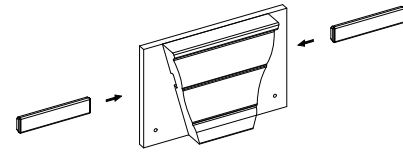

How to install Shims

(For OB only)

Use 2pcs of 2" screws to secure the bracket and shim as below drawing. Make sure the bracket holes align to the shim holes.

1pc for extend distance 3/8"

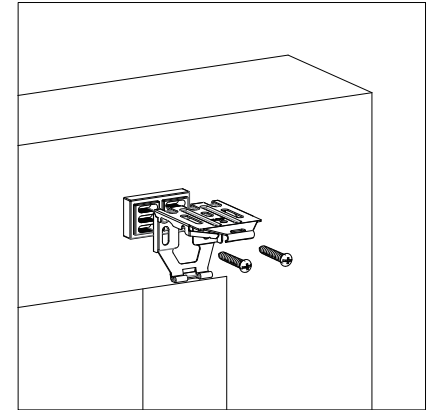

2pcs for extend distance 11/16"

